



## **SAW Components**

### **BAW Duplexer**

WCDMA Band II

<b>Series/type:</b>	<b>B7692</b>
<b>Ordering code:</b>	<b>B39202B7692A710</b>
<b>Date:</b>	<b>December 11, 2008</b>
<b>Version:</b>	<b>2.0</b>



**Application**

- Low-loss BAW duplexer for mobile telephone WCDMA Band II systems
- Low insertion attenuation
- Low amplitude ripple
- Usable passband 60 MHz

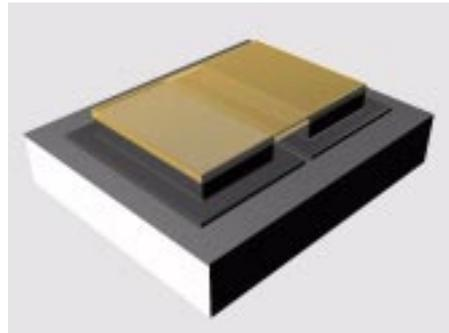

**Features**

- Package size 3.0 x 2.5 mm<sup>2</sup>, max. height 1.15 mm
- RoHS compatible
- Package for **Surface Mount Technology (SMT)**
- Ni, gold-plated terminals
- Fully matched by integrated matching network
- **Electrostatic Sensitive Device (ESD)**

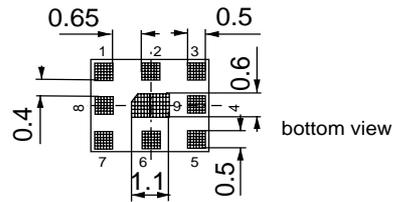

bottom view

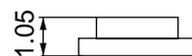

side view

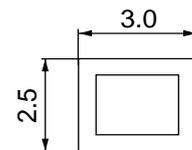

top view

**Pin configuration**

- 3 TX Input
- 1 RX Output
- 6 Antenna
- 7, 8, 9 To be grounded
- 2, 4, 5 To be grounded

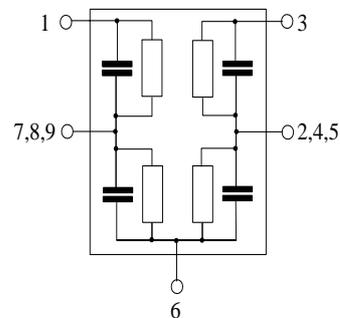



Data Sheet



Characteristics

Temperature range for specification: T = -10 °C to +85 °C  
 ANT terminating impedance: Z<sub>ANT</sub> = 50 Ω  
 RX terminating impedance: Z<sub>RX</sub> = 50 Ω  
 TX terminating impedance: Z<sub>TX</sub> = 50 Ω

Characteristics TX - ANT	min.	typ. @ 25°C	max.	
<b>Center frequency</b> f <sub>C</sub>		1880.0		MHz
<b>Maximum insertion attenuation</b>				
@f <sub>Carrier</sub> 1852.4 ... 1907.6MHz α <sub>WCDMA</sub> <sup>1)</sup>	-	2.2	3.0 <sup>2)</sup>	dB
@f <sub>Carrier</sub> 1852.4 ... 1907.6MHz α <sub>WCDMA</sub> <sup>1)</sup>	-	2.2	3.2 <sup>3)</sup>	dB
<b>Amplitude ripple (p-p)</b>				
@f <sub>Carrier</sub> 1852.4 ... 1907.6MHz α <sub>WCDMA</sub> <sup>1)</sup>	-	1.0	2.0	dB
<b>Error Vector Magnitude</b>				
@f <sub>Carrier</sub> 1852.4 ... 1907.6MHz EVM <sup>4)</sup>	-	1.2	3.8	%
<b>Input VSWR (TX port)</b>				
1850.0 ... 1910.0MHz	-	1.7	2.1 <sup>2)</sup>	
1850.0 ... 1910.0MHz	-	1.7	2.2 <sup>3)</sup>	
<b>Output VSWR (ANT port)</b>				
1850.0 ... 1910.0MHz	-	1.8	2.2	
<b>Attenuation</b> α				
50.0 ... 1574.0MHz	30	34	-	dB
1574.4 ... 1576.5MHz	36	41	-	dB
1770.0 ... 1830.0MHz	10	22	-	dB
@f <sub>Carrier</sub> 1932.4 ... 1987.6MHz α <sub>WCDMA</sub> <sup>1)</sup>	45	55	-	dB
2110.0 ... 2155.0MHz	20	38	-	dB
2400.0 ... 2500.0MHz	20	28	-	dB
3700.0 ... 3820.0MHz	14	20	-	dB
3820.0 ... 6000.0MHz	5	8	-	dB

1) Attenuation of WCDMA signal ("Powertransferfunction"). Please refer to annotation on page (6).  
 2) -10 to +55 °C  
 3) +55 to +85 °C  
 4) Error Vector Magnitude (EVM) based on definition given in 3GPP TS 25.141.



Data Sheet



Characteristics

Temperature range for specification: T = -10 °C to +85 °C  
 ANT terminating impedance: Z<sub>ANT</sub> = 50 Ω  
 RX terminating impedance: Z<sub>RX</sub> = 50 Ω  
 TX terminating impedance: Z<sub>TX</sub> = 50 Ω

Characteristics ANT- RX	min.	typ. @ 25°C	max.	
<b>Center frequency</b> f <sub>C</sub>		1960.0		MHz
<b>Maximum insertion attenuation</b> @f <sub>Carrier</sub> 1932.4 ... 1987.6MHz α <sub>WCDMA</sub> <sup>1)</sup>	-	2.6	3.5	dB
<b>Amplitude ripple (p-p)</b> @f <sub>Carrier</sub> 1932.4 ... 1987.6MHz α <sub>WCDMA</sub> <sup>1)</sup>	-	1.3	2.0	dB
<b>Error Vector Magnitude</b> @f <sub>Carrier</sub> 1932.4 ... 1987.6MHz EVM <sup>2)</sup>	-	2.0	3.8 <sup>3)</sup>	%
@f <sub>Carrier</sub> 1932.4 ... 1987.6MHz EVM <sup>2)</sup>	-	2.0	6.0 <sup>4)</sup>	%
<b>Input VSWR (ANT port)</b> 1930.0 ... 1990.0MHz	-	1.8	2.2	
<b>Output VSWR (RX port)</b> 1930.0 ... 1990.0MHz	-	1.8	2.2	
<b>Attenuation</b> α	-			
0.3 ... 1770.0MHz	30	35	-	dB
1770.0 ... 1850.0MHz	38	44	-	dB
@f <sub>Carrier</sub> 1852.4 ... 1907.6MHz α <sub>WCDMA</sub> <sup>1)</sup>	48	55	-	dB
2075.0 ... 2400.0MHz	15	40	-	dB
2400.0 ... 2500.0MHz	35	48	-	dB
3860.0 ... 3980.0MHz	30	50	-	dB
5620.0 ... 5820.0MHz	15	40	-	dB

1) Attenuation of WCDMA signal ("Powertransferfunction"). Please refer to annotation on page (6).  
 2) Error Vector Magnitude (EVM) based on definition given in 3GPP TS 25.141.  
 3) +10 °C to +85 °C.  
 4) -10 °C to +10 °C.



Data Sheet



Characteristics

Temperature range for specification:  $T = -10\text{ °C to }+85\text{ °C}$   
 Antenna terminating impedance:  $Z_{ANT} = 50\ \Omega$   
 RX terminating impedance:  $Z_{RX} = 50\ \Omega$   
 TX terminating impedance:  $Z_{TX} = 50\ \Omega$

IMD Product Level Limits at Rx frequencies and at Rx port <sup>1)</sup> (1930 ... 1990 MHz):		min.	typ. @ 25 °C	max.	
Blocker 1	80.0MHz	-	-112	-	dBm
Blocker 2	1770.0 ... 1830.0MHz	-	-110	-	dBm
Blocker 3	3840.0MHz	-	-86	-	dBm

<sup>1)</sup> IMD product level limits for power levels  $P_{TX} = 21\text{ dBm}$  (antenna port output power) and  $P_{Blocker} = -15\text{ dBm}$  (antenna port input power).

Characteristics TX - RX		min.	typ. @ 25 °C	max.	
<b>Isolation</b>	$\alpha$				
@ $f_{Carrier}$ 1852.4 ... 1907.6 MHz	$\alpha_{WCDMA}^{1)}$	50	54	-	dB
@ $f_{Carrier}$ 1932.4 ... 1987.6 MHz	$\alpha_{WCDMA}^{1)}$	48	54	-	dB

<sup>1)</sup> Attenuation of WCDMA signal ("Powertransferfunction"). Please refer to annotation on page (6).



**SAW Components** **B7692**

**BAW Duplexer** **1880.0 / 1960.0 MHz**

Data Sheet



**Maximum ratings**

Temperature range for specification	T	-10/+85	°C	
Operable temperature range <sup>1)</sup>	T	-30/+85	°C	
Storage temperature range	T <sub>stg</sub>	-40/+85	°C	
DC voltage	V <sub>DC</sub>	3	V	
ESD voltage	V <sub>ESD</sub>	100 <sup>2)</sup>	V	machine model, 10 pulses
Input power at 1850.0 ... 1910.0 MHz	P <sub>IN</sub>	30	dBm	} source and load impedance 50 Ω continuous wave T = 55° C, 50.000 h
elsewhere		10	dBm	

1) Defines the temperature range in which the BAW device keeps its typical characteristics, however the specification values are not guaranteed.

2) acc. to JESD22-A115A (machine model), 10 negative & 10 positive pulses.

**Annotation for characteristics section**

Attenuation of WCDMA signal ("Powertransferfunction",  $\alpha_{WCDMA}$ ) is determined by

$$\int_{-\infty}^{\infty} |S_{ds21}(f)H_{RRC}(f - f_{Carrier})|^2 df$$

$f_{Carrier}$  according to 3GPP TS 25.101 (e.g. for UMTS-Passband,  $f_{Carrier}$  ranges from 882.4 MHz (lowest Tx channel) to 912.6 MHz (highest Tx channel)).  $H_{RRC}(f)$  is the transfer function of the root-raised cosine transmit pulse shaping filter according to 3GPP TS 25.101 with the following normalization:

$$\int_{-\infty}^{\infty} |H_{RRC}(f)|^2 df = 1$$



Frequency Response TX-ANT (PTF)

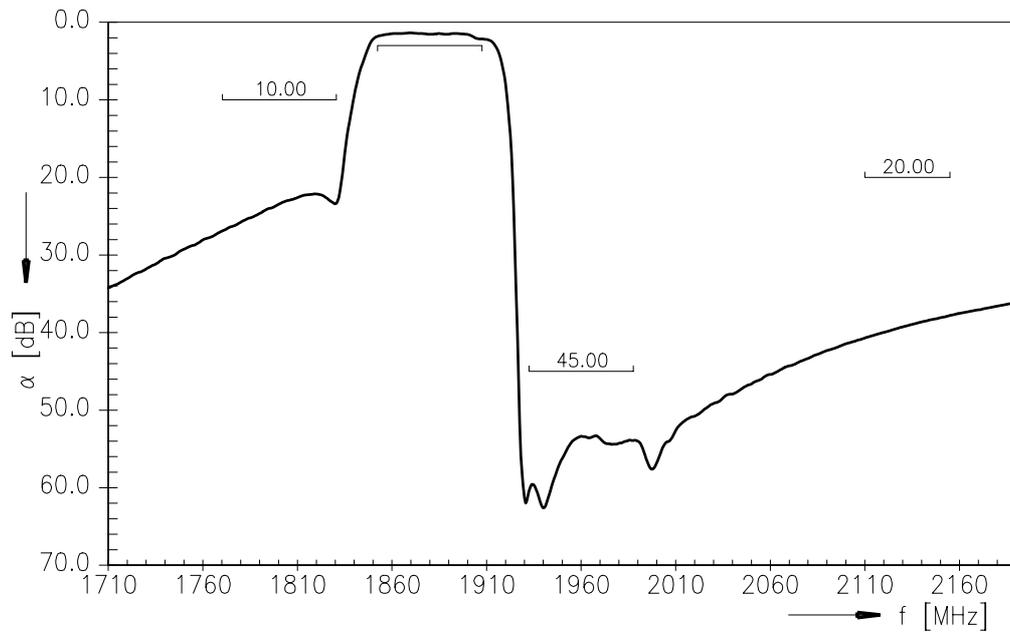

Frequency Response TX-ANT (wideband)

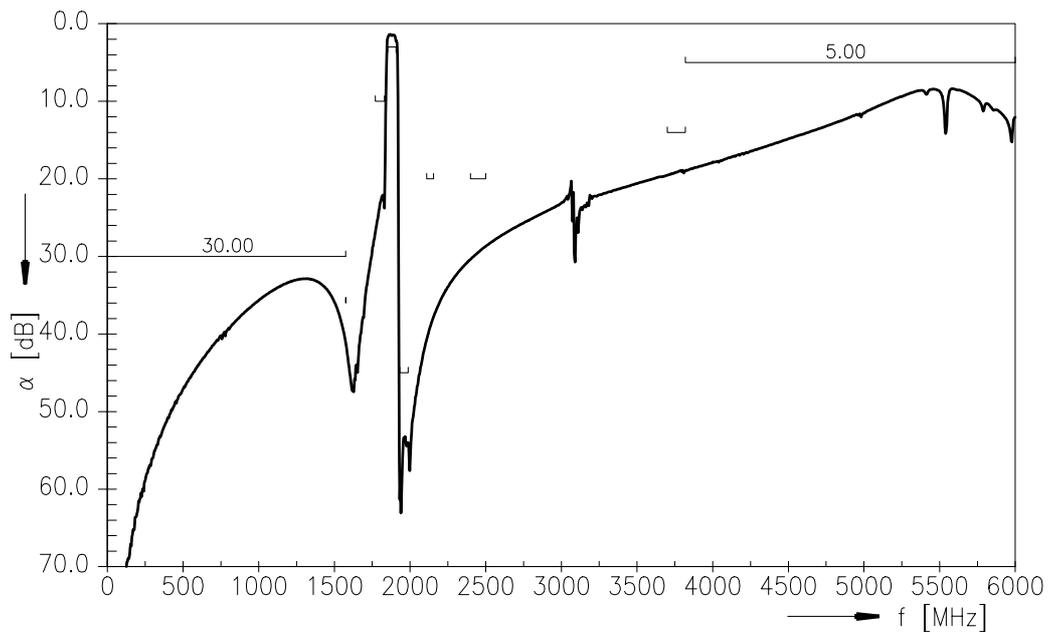



Frequency Response ANT-RX (PTF)

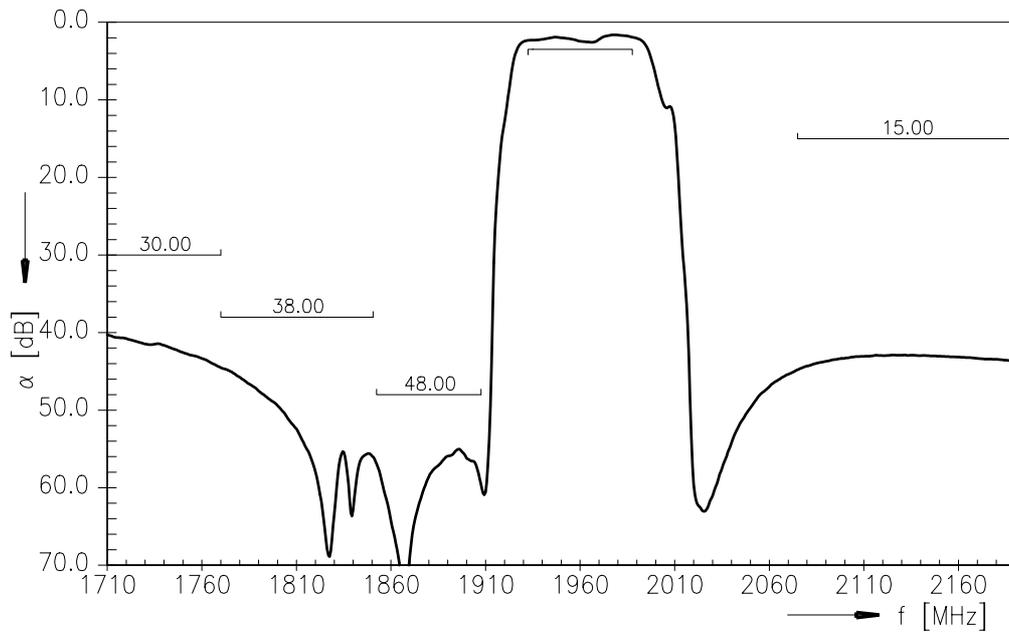

Frequency Response ANT-RX (wideband)

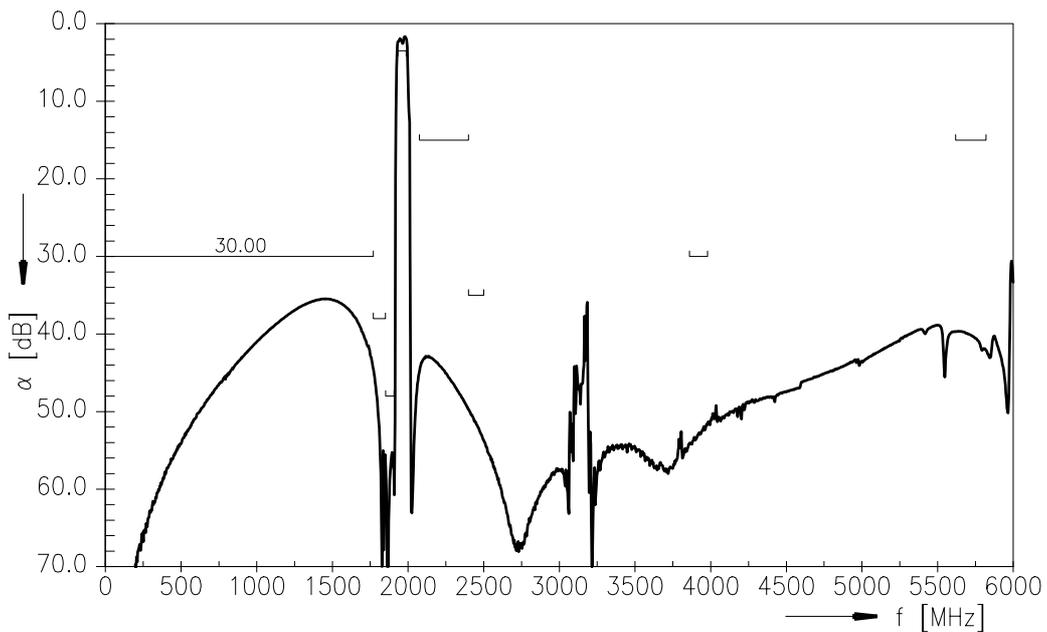



SAW Components

B7692

BAW Duplexer

1880.0 / 1960.0 MHz

Data Sheet



Frequency Response TX-RX (PTF)

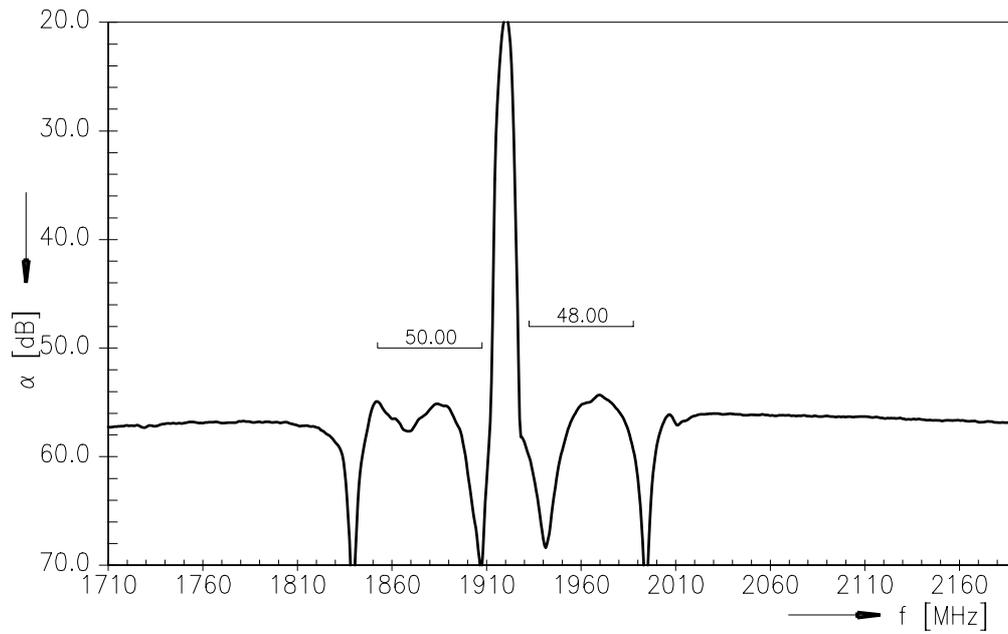

Please read *cautions and warnings and important notes* at the end of this document.

**SAW Components****B7692****BAW Duplexer****1880.0 / 1960.0 MHz**

Data Sheet

**References**

<b>Type</b>	B7692
<b>Ordering code</b>	B39202B7692A710
<b>Marking and package</b>	C61157-A3-A47
<b>Packaging</b>	F6107-V8211-Z000
<b>Date codes</b>	L_1126
<b>S-parameters</b>	B7692_NB.s3p B7692_WB.s3p See file header for pin/port assignment
<b>Soldering profile</b>	S_6001
<b>RoHS compatible</b>	defined as compatible with the following documents: "DIRECTIVE 2002/95/EC OF THE EUROPEAN PARLIAMENT AND OF THE COUNCIL of 27 January 2003 on the restriction of the use of certain hazardous substances in electrical and electronic equipment. 2005/618/EC from April 18th, 2005, amending Directive 2002/95/EC of the European Parliament and of the Council for the purposes of establishing the maximum concentration values for certain hazardous substances in electrical and electronic equipment."

**For further information please contact your local EPCOS sales office or visit our webpage at [www.epcos.com](http://www.epcos.com) .**

**Published by EPCOS AG  
Surface Acoustic Wave Components Division  
P.O. Box 80 17 09, 81617 Munich, GERMANY**

© EPCOS AG 2008. This brochure replaces the previous edition.

For questions on technology, prices and delivery please contact the Sales Offices of EPCOS AG or the international Representatives.

Due to technical requirements components may contain dangerous substances. For information on the type in question please also contact one of our Sales Offices.

Please read *cautions and warnings and important notes* at the end of this document.



## Important notes

The following applies to all products named in this publication:

1. Some parts of this publication contain **statements about the suitability of our products for certain areas of application**. These statements are based on our knowledge of typical requirements that are often placed on our products in the areas of application concerned. We nevertheless expressly point out **that such statements cannot be regarded as binding statements about the suitability of our products for a particular customer application**. As a rule, EPCOS is either unfamiliar with individual customer applications or less familiar with them than the customers themselves. For these reasons, it is always ultimately incumbent on the customer to check and decide whether an EPCOS product with the properties described in the product specification is suitable for use in a particular customer application.
2. We also point out that **in individual cases, a malfunction of electronic components or failure before the end of their usual service life cannot be completely ruled out in the current state of the art, even if they are operated as specified**. In customer applications requiring a very high level of operational safety and especially in customer applications in which the malfunction or failure of an electronic component could endanger human life or health (e.g. in accident prevention or life-saving systems), it must therefore be ensured by means of suitable design of the customer application or other action taken by the customer (e.g. installation of protective circuitry or redundancy) that no injury or damage is sustained by third parties in the event of malfunction or failure of an electronic component.
3. **The warnings, cautions and product-specific notes must be observed.**
4. In order to satisfy certain technical requirements, **some of the products described in this publication may contain substances subject to restrictions in certain jurisdictions (e.g. because they are classed as hazardous)**. Useful information on this will be found in our Material Data Sheets on the Internet ([www.epcos.com/material](http://www.epcos.com/material)). Should you have any more detailed questions, please contact our sales offices.
5. We constantly strive to improve our products. Consequently, **the products described in this publication may change from time to time**. The same is true of the corresponding product specifications. Please check therefore to what extent product descriptions and specifications contained in this publication are still applicable before or when you place an order. We also **reserve the right to discontinue production and delivery of products**. Consequently, we cannot guarantee that all products named in this publication will always be available. The aforementioned does not apply in the case of individual agreements deviating from the foregoing for customer-specific products.
6. Unless otherwise agreed in individual contracts, **all orders are subject to the current version of the "General Terms of Delivery for Products and Services in the Electrical Industry" published by the German Electrical and Electronics Industry Association (ZVEI)**.
7. The trade names EPCOS, BAOKE, Alu-X, CeraDiode, CSSP, CTVS, DSSP, MiniBlue, MKK, MLSC, MotorCap, PCC, PhaseCap, PhaseMod, SIFERRIT, SIFI, SIKOREL, SilverCap, SIM-DAD, SIMID, SineFormer, SIOV, SIP5D, SIP5K, ThermoFuse, WindCap are **trademarks registered or pending** in Europe and in other countries. Further information will be found on the Internet at [www.epcos.com/trademarks](http://www.epcos.com/trademarks).